

Technical data sheet for

GAS COOKTOPS 900mm – 4 BURNER

RN8900G-B, RN8900G-CB, RN8900G-LS, RN8900G-RB



RN8900G-LS

- Heavy-duty construction
- Four 28 MJ/hr open burners
- Flame failure standard
- Pilot burners optional
- 3 models of base unit
- 1 model of refrigerated base with two GN 1/1 drawers
- Stainless steel exterior
- Easy clean
- Easy service
- Fully modular
- Low back models (RNL) available

Overall Construction

COOKTOP

- Welded hob with 1.5mm 304 stainless steel bull nose
- Splashback and side panels 1.2mm 304 stainless steel
- Front panels 0.9mm 304 stainless steel
- Cast iron 28MJ/hr open burners with forged brass cap
- Vitreous enamelled cast iron potstands
- Vitreous enamelled open burner spill covers
- Stainless steel spill trays

CABINET BASE (SUPPLIED AS –CB MODEL)

- Fully modular for match suite finish
- Double skin 0.9mm 304 stainless steel interior and exterior
- Optional GN 1/1 4 position racking kit
- 63mm dia. heavy-duty 1.2mm 304 stainless steel legs with adjustable feet

LEG STAND (SUPPLIED AS –LS MODEL)

- Fully modular for matched suite finish
- Framed top for connection to Cooktop
- 63mm dia. heavy-duty 1.2mm 304 stainless steel legs with adjustable feet
- Fully modular framed stand shelf with 0.9mm 304 stainless steel finish
- Suitable for rear or through shelf gas connection to Cooktop
- Quick assembly design (no tools required)

REFRIGERATED BASE (SUPPLIED AS –RB MODEL)

- Self contained suite matched modular base
- Ventilated system with R134a refrigerant
- -2° to + 8°C temperature (Tropical Climate rated)
- Two GN 1/1 drawers
- 100mm deep pan capacity
- Heavy-duty European telescopic drawer guides
- Magnetic drawer gaskets (replaceable without tools)
- 50mm fully foamed CFC free insulation
- 304 stainless steel exterior and interior
- Anti-corrosion treated evaporator
- No condensate drain required
- 63mm dia. heavy-duty 1.2mm 304 stainless steel legs with adjustable feet
- Condensing unit removable through front of unit for service
- Easy clean interior

Controls

COOKTOP

- Variable high to low controls to open burners
- Open burners flame failure standard with pilot burners optional
- Large easy use control knob - heat resistant reinforced
- Easy view control settings on knob

REFRIGERATED BASE

- Digital control electronic thermostat
- Automatic defrost
- Automatic evaporation of defrost water
- -2° to +8°C temperature range

Cleaning and Servicing

- All models with easy clean stainless steel external finish
- Lift off burner heads and vitreous enamelled burner spill covers
- Stainless steel spill trays under open burners
- Access to all parts from front of unit
- Refrigerated Base condenser removable through front of unit

Technical data sheet for

GAS COOKTOPS 900mm – 4 BURNER



Specifications

Burners

28MJ/hr dual flame ring with simmer rate

Gas power

112 MJ/hr, 31kW

Gas connection

R 3/4 (BSP) male

130mm from RH side, 32mm from rear, and 655mm from floor

All units supplied with Natural and LP gas regulator

REFRIGERATED BASE

Type

Ventilated system

Refrigerant

R134a (160grams)

Climate classification

T – tropical

Electrical connection

220-240Vac, 50Hz, 1.8A, 1P+N+E

3 pin 10A plug cordset fitted

DIMENSIONS

Bench models

Width 900mm

Depth 805mm

Height 315mm

Incl. splashback 530mm

Incl. low back 370mm

All models (excluding Bench models)

Width 900mm

Depth 805mm

Height 915mm

Incl. splashback 1130mm

Incl. low back 970mm

NETT WEIGHT

Bench and Leg Stand models

129kg

Cabinet Base and Refrigerated Base models

180kg

PACKING DATA

Bench and Leg Stand models

0.55m³, 174kg

Width 945mm

Depth 870mm

Height 665mm

Cabinet Base and Refrigerated Base models

1.03m³, 245kg

Width 945mm

Depth 870mm

Height 1255mm

GAS TYPES

Available in Natural gas and LP gas

Please specify when ordering

Units supplied complete with gas type conversion kits

Other gas types on request

OPTIONS AT EXTRA COST

Joining caps

Castors

Plinth mounting

RN8900G-B

BENCH MODEL

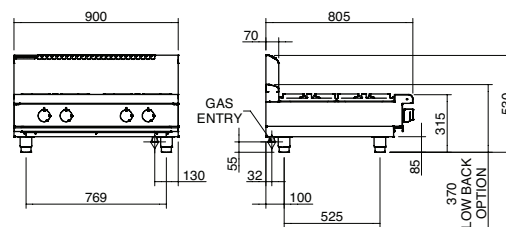

RN8900G-CB

CABINET BASE

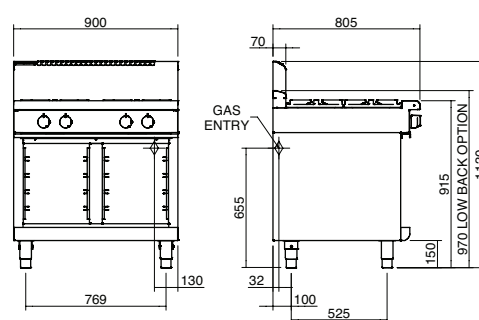

RN8900G-LS

LEG STAND

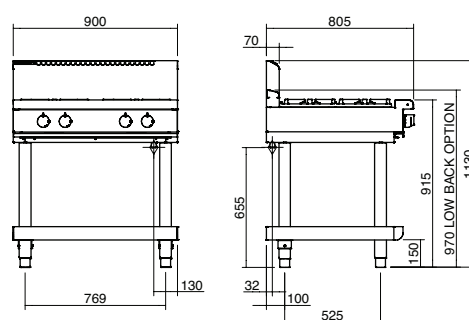

RN8900G-RB

REFRIGERATED BASE

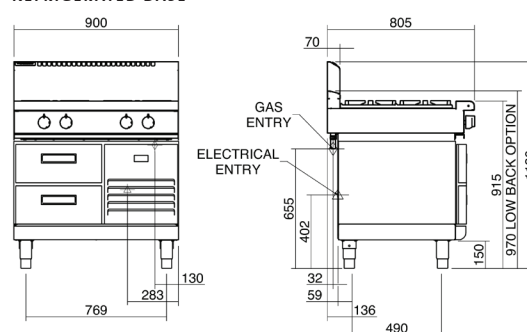

RN8900G

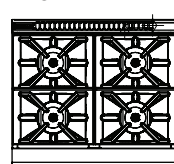

moffat.com.au
moffat.co.nz

Australia
moffat.com.au

Moffat Pty Limited

Victoria/Tasmania
740 Springvale Road
Mulgrave, Victoria 3170
Telephone +613-9518 3888
Facsimile +613-9518 3833
vsales@moffat.com.au

New South Wales
Telephone +612-8833 4111
nswsales@moffat.com.au

South Australia
Telephone +612-9518 3888
vsales@moffat.com.au

Queensland
Telephone +617-3630 8600
qldsales@moffat.com.au

Western Australia
Telephone +618-9413 2400
wasales@moffat.com.au

New Zealand
moffat.co.nz

Moffat Limited

Rolleston
45 Illinois Drive
Izone Business Hub
Rolleston 7675
Telephone +64 3-983 6600
Facsimile +64 3-983 6660
sales@moffat.co.nz

Auckland
Telephone +64 9-574 3150
sales@moffat.co.nz



ISO9001
Quality
Management
Standard



Cert. No. 6902

In line with policy to continually develop and improve its products, Moffat Limited reserves the right to change specifications and design without notice.

© Copyright Moffat Ltd
AN.W8.08/19

an Ali Group Company



The Spirit of Excellence