

Zip HydroTap for the workplace



PURE-TASTING | INSTANT | **BOILING** | CHILLED | **SPARKLING**



POWERED BY
G5
TECHNOLOGY

Experience water at its best



Introduction	2
Water at its best	3
Classic Plus	7
Touch-Free Wave	8
Zip Micro	9
UltraCare	10
G5 technology	11
Filtration technology	13
Healthier workplace	14
Widest range and finishes	15
Environmental product declaration	17
Safe and accessible	19
Zip service difference	20
Zip innovation history timeline	21

HydroTap Classic range	
Touch-Free Wave	25
Touch-Free Wave with Mixer	26
Classic Plus	27
Classic Plus with Mixer	28
Classic	29
Classic with Mixer	30
Classic All-In-One	31
Classic Industrial	32
Classic for accessibility	33

HydroTap Design range	
Arc	35
Arc with Mixer	36
Cube	37
Cube with Mixer	38
Elite Plus	39
Elite Plus with Mixer	40

HydroTap Celsius range	
Celsius All-In-One	42
Celsius Arc	43
Celsius Cube	44
Micro	45

Technical data	
Classic Plus	46
Touch-Free Wave	48
Classic	50
Industrial	52
UltraCare	52
Arc	53
Cube	54
Elite Plus	55
Celsius All-In-One	57
Celsius Arc	57
Celsius Cube	57
Technical information	58

Consumables and accessories	
Accessories	60
Installation accessories	61
HydroTap filters and CO ₂	61



70 years of innovation

With unrivalled expertise in instant filtered boiling, chilled and sparkling water, Zip Water is known globally for being home to the Zip HydroTap, which dispenses pure-tasting water at the touch of a button.

Founded in Australia in 1947, we've always been innovators, advancing and perfecting our drinking water technology for decades. Today, we're proud to provide workplaces, in over 70 countries across the world with the purest tasting water possible from our range of Zip HydroTaps.

Access the latest water filtration technology for pure-tasting water. Convenience at the touch of a button for instant boiled, chilled and sparkling water. Stylish designs and finishes to suit any kitchen and declutter bench space for efficiency. Keep up with the busy demands of a workplace with Zip HydroTap technology. We provide drinking water solutions for all workplaces - offices, health and aged care facilities, small businesses and workplaces looking to reduce shared touchpoints.

Experience water at its best with Zip HydroTap.

John Doumani, President Zip Industries

Featured product
HydroTap Classic Plus in Chrome finish



Experience water at its best with Zip HydroTap

Convenience of instant pure-tasting water at the touch of a button

Enjoy pure-tasting boiling, chilled and sparkling water flowing from the simplest of touches with the Zip HydroTap G5. With sleek design and slick function powered by our most advanced technology, the HydroTap G5 has more personalised settings and features SteriTouch® for enhanced hygiene. It's not just water, it's water at its best.



FILTERED
BOILING



FILTERED
CHILLED



FILTERED
SPARKLING



FILTERED
AMBIENT



UNFILTERED
HOT & COLD



POWERED BY
G5
TECHNOLOGY

Powered by our latest G5 technology

Zip HydroTap's superior filtration and compact, efficient design makes it the perfect water solution for any workspace.

Remove kettles from your benchtops. Eliminate refrigerated bottles of still and sparkling water. Save space, energy and money. Forget deliveries and storage of water cooler bottles.

The Zip HydroTap is a convenient and practical way to offer your staff, customers and visitors fresh, pure-tasting water – instantly and safely.

Experience water at its best with HydroTap in the workplace

Pure-tasting boiling, chilled and sparkling water in an instant, delivered seamlessly with a Zip HydroTap. There is a HydroTap to suit any workplace.

For the office workplace

Workplace productivity and wellbeing is vital to every team environment. Zip HydroTap meets all your workplace water needs, in one elegant, easy-to-use system, using the latest technology to keep up with a busy workplace. Introducing our latest addition to our flagship HydroTap range - Classic Plus.



For touch-free workplaces

With an increased consideration around hygiene in the workplace, Zip HydroTap Touch-Free Wave provides a 100% touch-free solution to instantly dispense pure-tasting drinking water with a simple wave of a hand.



For the small workplace

Award winning Zip Micro is our smallest ever drinking water system, designed to fit under almost any bench and keeps up to 10 people hydrated – the perfect solution for smaller offices.



For health and aged care facilities

For health and aged care facilities, HydroTap UltraCare is proven to deliver a 99.9% reduction in Legionella*.



*ALS Pty Ltd Testing of the Zip HydroTap UltraCare system efficacy tests



Featured product HydroTap Classic All-In-One installed over sink in Matte Black finish

Say hello to the new Classic Plus

Sleek design meets slick function

With simple, intuitive controls including continuous flow to fill bottles and coming in seven ultra-modern finishes, HydroTap Classic Plus will offer instant hydration and convenience to any workplace.

Smarter and sustainable

Customise your HydroTap G5 system by selecting energy modes and usage settings with the optimised new menu. With easy to change high quality filters, a Zip HydroTap will support your sustainability ambitions and remove the need for bottled water in the workplace.

Protection where it counts

Zip HydroTap G5 has SteriTouch® antimicrobial protection impregnated within key water surfaces as well as on the new Classic Plus touch-pad for enhanced hygiene.



Create a safer workplace with HydroTap Touch-Free Wave



Available in Chrome and Matte Black

Introducing Zip HydroTap Touch-Free Wave, with smart infrared sensors that activate boiling, chilled and sparkling water.

With an increased consideration around hygiene in the workplace, new Zip HydroTap Touch-Free Wave provides a 100% touch-free solution to instantly dispense pure-tasting drinking water with a simple wave of a hand.

How it works

- Infrared smart sensors detect hand movements within 1.5 - 5cm in range of the tap
- Once the hand moves away, the water flow will stop
- All drinking water types will have a maximum run time of 15 seconds which is adjustable from the command centre
- Continuous flow to fill bottles with twin sensor activation

Safety features

- Twin sensor activation for safe delivery of boiling water



- Dispensing will deactivate when the tap is touched or grabbed, allowing for safe cleaning



Wave right for chilled



Wave above for sparkling



Twin sensor activation for boiling



Infrared sensor



Touch-free activation



1.5-5cm sensor range



Deactivates when touched



Patent pending-Zip HydroTap Touch-Free Wave sensor activation. Scan QR code on the right hand side to find out more information on Touch-Free Wave.

Note: HydroTap Touch-Free Wave in Matte Black features a two tone finish, with a matte black tap body and chrome sensor head.

Zip Micro, our smallest ever drinking water system





Zip Micro is 37% narrower, perfect for small kitchens for up to 10 people, delivering perfectly **boiling** and **chilled** water at your fingertips.



- 

Designed with space in mind
Our smallest underbench system footprint is 37%* narrower.
- 

Optimised for up to 10 people
Keep up to 10 people hydrated with boiling only or boiling + chilled filtered water options.
- 

Easy to use
The Zip Micro tap design comes with an integrated safety lock and uses an intuitive twist activation with auto and manual fill options. The underbench system comes with pre-configured settings and modes.
- 

Micro-filtration for pure tasting water
Zip Micro uses the latest filtration technology for pure-tasting water. Zip filters are certified to reduce bacteria, sediment, odours to NSF 42 (aesthetic effects) and NSF 53 (health effects).



2020 Gold Accolade Winner
in the Product Design Domestic Appliances category in recognition for outstanding design and innovation.

The Zip HydroTap UltraCare system is proven to deliver 99.9% reduction in Legionella*

Zip HydroTap UltraCare uses a combination of localised treatments and barriers that are proven as the most effective method of reducing waterborne organisms and pathogens including Legionella**.

The barriers provided in the UltraCare system are:

- MicroPurity™ 0.2-micron carbon-free filtration
- SteriTouch® antimicrobial enhanced surfaces
- MicroPurity™ UV-C LED disinfection
- Lifecycle maintenance plan
- Zip HydroCare Gold+

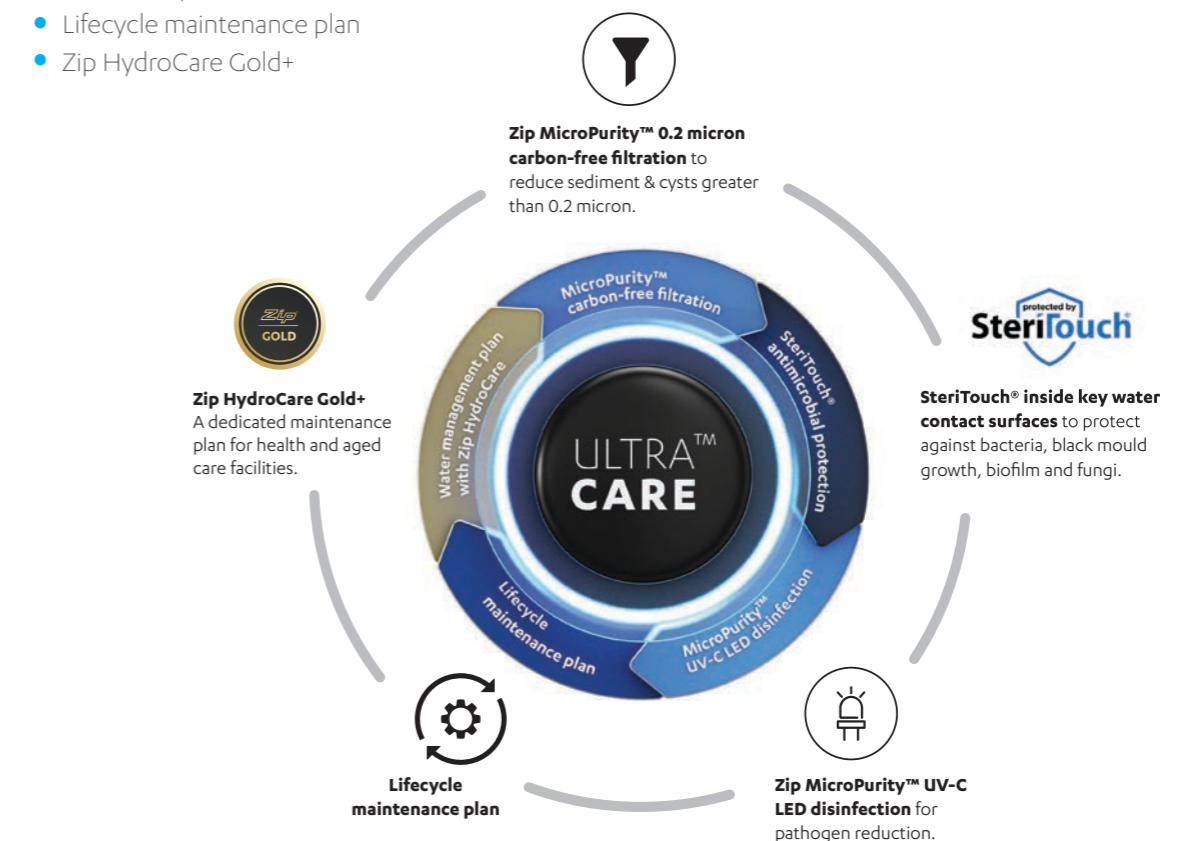

*ALS Pty Ltd Testing of the Zip HydroTap UltraCare system efficacy tests.

**enHealth 2015 Guidelines for Legionella control in the operation and maintenance of water distribution systems in health and aged care facilities, Australian Government, Canberra.

HydroTap, powered by new G5 technology

Leading the way in performance and functionality, Zip's fifth generation G5 technology continues to deliver the convenience you would expect from a HydroTap.

Perfected over 70 years of development and innovation, HydroTap G5 transforms tap water into a form you will love, in an instant.

The G5 command centre is WaterMark approved, which means it is fit for purpose and appropriately authorised for use in plumbing and drainage installations.



HydroTap product warranty

Zip HydroTap G5 is backed by a 36 month comprehensive parts and labour warranty, plus a further 24 months on internal tanks.

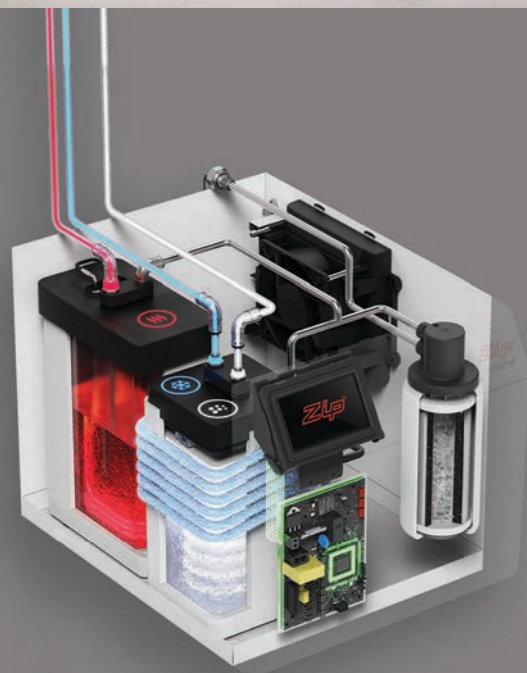
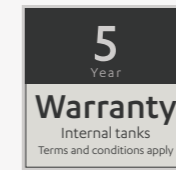

PowerPulse technology



Our innovative Zip PowerPulse technology maintains stored boiling water to within 0.2°C of your set temperature, meaning no energy or time is wasted waiting for water to boil.

Unique safety features



Zip boiling water is delivered smoothly and the tap has a safety lock to facilitate safe boiling water delivery.

Air-cooled system



Our unique air-cooled refrigeration system is 100% water efficient.

Auto-diagnostics



An advanced auto-diagnostics system continuously monitors your HydroTap's performance.

MicroPurity™ filtration



Inbuilt 0.2 micron NSF-certified filter incorporating innovative silver ion antimicrobial technology means healthier, pure-tasting water for your workplace.

Smart Customisation



New optimised menu in the G5 HydroTap command centre allows you to select energy modes and usage settings for easier customisation.

SteriTouch® antimicrobial protection



SteriTouch® is impregnated inside materials in contact with key water paths in HydroTap for added protection against surface bacteria.

Touch-Free Technology



Zip HydroTap Touch-Free Wave uses smart infrared sensors to activate the tap to dispense boiling, chilled and sparkling water, all without touching the tap.

CO₂ level indicator



New feature in the command centre shows when CO₂ gas is running low.



Pure-tasting filtered water with Zip MicroPurity filtration

At Zip Water, we put water quality at the heart of our offering, with perfectly filtered boiling, chilled and sparkling water instantly.

Our mission is to help our customers to enjoy pure-tasting water, on tap, all the time, and that is why only the best tasting water will do.

Advanced filtration in every HydroTap system

Zip MicroPurity uses the latest filtration technology to filter and reduce impurities and potentially harmful contaminants larger than 0.2 microns in size – an impurity that will fit 250 times into a strand of hair.

Easy to maintain

We recommend regular filter changes to ensure you continue to enjoy pure-tasting water. Our MicroPurity filters are easy to change with a hygienic cartridge and our qualified service technicians can also perform filter changes for your convenience.

Trust Zip genuine filters

Every Zip HydroTap system comes fitted with a genuine MicroPurity filter, certified to reduce contaminants.

Crystal clear pure-tasting water

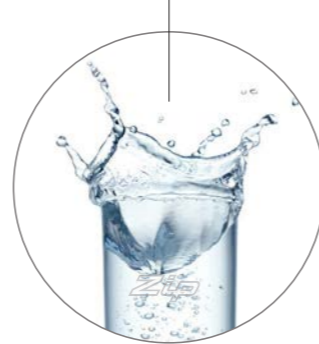

**MICROPURITY™
FILTRATION**
SAFELY FILTERS DOWN TO 0.2 MICRON

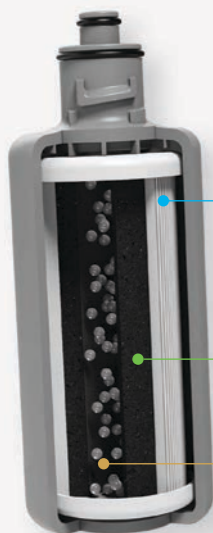

Triple Action Technology

- 1. Removes particulates greater than 5 micron**
Pleated membrane pre-filtration
- 2. Filter reduces particulates, lead, chlorine, taste, odour and cysts to 0.2 micron**
0.2 micron Fibredyne carbon element including bacteriostatic effect
- 3. Reduces limescale build up**
Limescale inhibitor

Zip MicroPurity filters are certified to reduce chlorine, taste, odour, bacteria, sediment and limescale in line with NSF 42 (aesthetic effects) and WaterMark requirements.

Zip MicroPurity filtration is also certified to deliver a reduction of 99.9% of cysts including cryptosporidium and giardia, and lead reduction of 98.9% to NSF 53 (health effects).



Water for a healthier workplace

Workplace wellness and wellbeing is vital to your team remaining engaged and productive. Water plays a significant role in the function of the brain, so ensuring your staff have access to fresh, healthy water is essential.

Zip Water research shows that 80% of Zip HydroTap owners drink more water than before*. Drinking more water offers a range of benefits, such as better concentration and less fatigue. Plus, the increased activity from getting up and moving around increases circulation, encourages the elimination of waste and toxins, and reduces the damaging effects of long periods of inactivity.

Zip HydroTap meets all your workplace water solution needs, in one elegant, easy to use system.

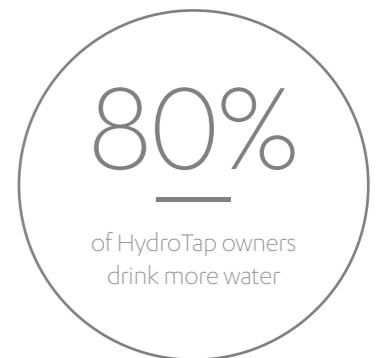

*Research carried out to 340 existing Zip HydroTap customers

The widest range of designs and finishes



NEW Touch-Free Wave*
 NEW Classic Plus
 NEW Elite Plus
 Classic**
 Classic All-In-One**
 Micro***
 Arc
 Cube
 Celsius All-In-One
 Celsius Arc
 Celsius Cube

Popular finish options

Whether you opt for a classic Chrome or stylish Matte Black, our range of timeless popular finishes has been designed to sit seamlessly in a wide range of kitchen designs, from contemporary to traditional.



Platinum finish options

Taking the HydroTap from a kitchen appliance you can't live without to a striking design accessory, our platinum finish options include stylish metallic finishes, each stunning in its own right.



*Available in Chrome and Matte Black two tone finish.
 **Available only in popular finish options
 ***Available only in Chrome and Matte Black finish options

Environmentally responsible

Independently verified Environmental Product Declaration

In another first for the world leaders in instant drinking water systems, Zip has released an internationally recognised and independently verified Environmental Product Declaration (EPD) for its HydroTap products. Developed with leading sustainability consulting company, **thinkstep***, it is the first EPD for an electrical product in Australasia, clearly demonstrating Zip's innovative and forward-thinking approach.

The HydroTap EPD details the environmental impact of the product throughout its life cycle, from the production and processing of raw materials, to manufacturing, distribution, installation, ongoing usage, maintenance and filter changing, right down to the end of the product's life.

Australians buy **over 580 MILLION** litres of bottled water a year.

Much of which ends up in **LANDFILL** and on our **BEACHES#**

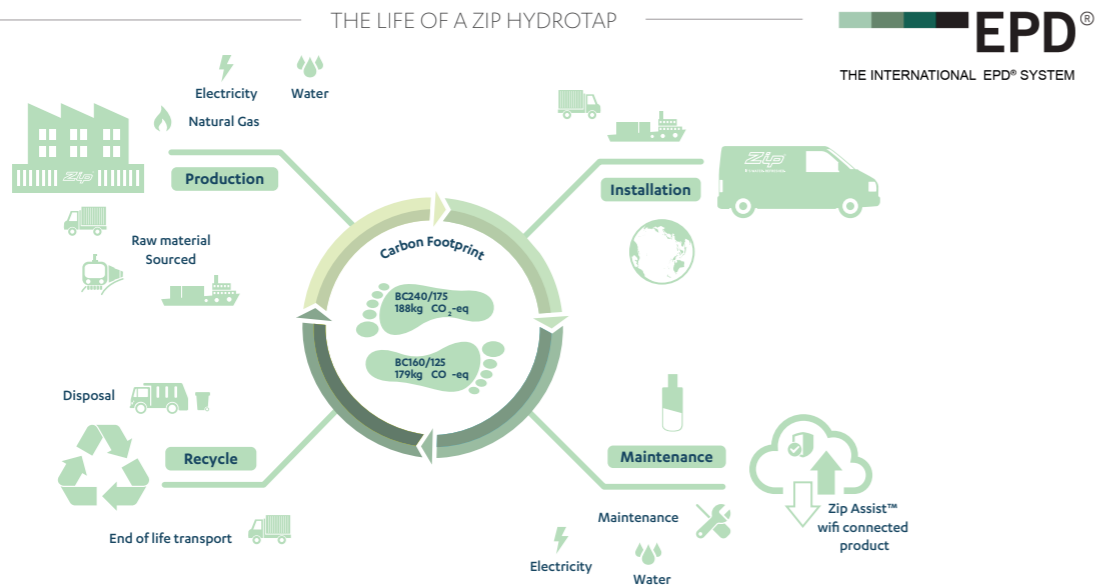

EPD[®]
THE INTERNATIONAL EPD[®] SYSTEM

Responsible manufacturing

Organisational dedication to sustainability



Innovative air-cooled technology

Making HydroTap 100% water efficient



Low impact design

Complies with RoHS EU Directive 2002/95/EC



Smart energy saving modes

Time switch adheres to the Building Code of Australia



World class environmental credentials

Providing transparent product life cycle impact



Eliminates the need for bottled water

Reducing your environmental impact



Sustainable manufacturing

Zip Water products are Australian-made in Condell Park, New South Wales and exported to the rest of the world. Our manufacturing adheres to the highest standards of environmental responsibility and ensures the Zip HydroTap is manufactured sustainably.

ISO14001 is about much more than just designing an energy efficient product. It is complete organisational dedication to sustainable environmental management and ensures genuine commitment to a sound environment management system.

Zip Water is the only Australian manufacturer in our category to be accredited with all of the following internationally recognised standards:

ISO14001 –

Environmental Systems compliance and independently audited standards



ISO9001 –

Quality Management System



AS/NZS 4801 –

Workplace Health and Safety System



*oceanrangers.org/plastic-crusades/plastic-statistics/
*Thinkstep certified life cycle assessment and EPD verifiers - www.thinkstep-anz.com

Safe and accessible

All Zip products are designed to be completely safe and easy to use, with unique boiling water safety locks and cool touch technology. You can be confident that the end user can operate our systems safely, without needing to worry about spluttering steam.

For users with limited mobility or impaired vision, Zip HydroTap Classic is also available with accessible levers. The oversized levers incorporates braille into the colour coded red and blue options to indicate boiling or chilled drinking water.

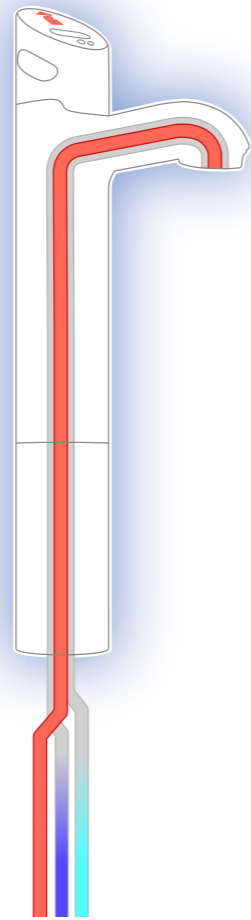

Featured product
HydroTap Classic with oversized levers and braille covers.



The Zip service difference



Our highly skilled network of mobile technicians and friendly customer service team are here to help keep your Zip products in top working order. Our expert technicians install HydroTaps across residential and commercial kitchens, and we can maintain any drinking water systems.

Full national coverage

With more than 100 Zip specialised technicians and 270 authorised service providers across the country, fully trained and qualified support is never far away.

Fast and efficient

Every Zip service technician carries a range of spare parts, genuine filters and CO₂ cannisters to repair on first time attendance, which means you can get back to enjoying your fresh, filtered water in no time.

Professional repairs and maintenance

Zip technicians are highly skilled, specialised and factory trained with years of experience to ensure you receive efficient, reliable and prompt service and repairs.

Be informed with updates

Get up-to-date SMS notifications when your Zip service technician is on their way to your service call to save you time in your day.

Customer satisfaction

We aim to provide our customers with professional care at a high standard and take pride on our level of service. Over 9000 customers rated the Zip service experience a 9 or 10 out of 10 in 2020.

HydroTap product warranty

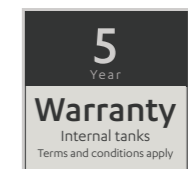
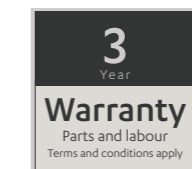

Let Zip take care of the installation

Zip Water offers an installation service, with a national fleet of skilled service technicians who can install your HydroTap in any kitchen.

Our service technicians will make sure your HydroTap is up and running in no time and includes stone cutting for tap and font installation.

Our service technicians can also help maintain your HydroTap, with a simple online booking form on zipwater.com

Preventative maintenance plans

For ultimate peace of mind, Zip Water offers professional care of your system with a comprehensive range of HydroCare packages covering every maintenance requirement.

With everything you need to enjoy pure-tasting water, HydroCare ensures your HydroTap not only remains in perfect condition but operates at peak performance.

A history of drinking water innovation for over 70 years

Zip Water is a world-leading designer and manufacturer of instant boiling, chilled and sparkling filtered water solutions. Zip Water invests in Australian-based innovation design and world-class manufacturing to continually enhance water quality, functionality, energy efficiency and aesthetic appeal. Recognised as a global innovator, Zip Water's products are sought after and installed in over 75 countries worldwide, providing homes and workplaces with the purest-tasting, safest and cleanest water possible.



<p>1947 Zip founded in Australia as manufacturer of sink and bath heaters</p>	<p>1975 Zip invents the world's first small On-Wall instant boiling water system</p>	<p>1980 World's first small on-wall instant boiling water system installed</p>	<p>1984 Zip Miniboil wins Australian design award</p>	<p>1988 Zip TeaTap specified into Parliament House Canberra</p>	<p>1991 Zip opens in the United Kingdom and soon wins a place in 10 Downing Street</p>	<p>1993 Zip upgrades technology for Hydroboil On-Wall instant boiling water</p>	<p>1996 Zip launches HydroTap underbench instant boiling water</p>	<p>2004 Zip HydroTap redesigned wins Australian Design Mark</p>	<p>2007 Zip introduces advanced electronically controlled Hydroboil</p>	<p>2012 Zip introduces world's first boiling, chilled and sparkling water on tap</p>
<p>1947 ————— 2021</p>										
<p>2014 Zip introduces G4, the fourth generation of HydroTap</p>	<p>2015 Zip introduces three new styles with Design Range launch and wins Good Design Award</p>	<p>2016 Zip introduces eight new Platinum finishes Zip launches Zip Assist wifi connected HydroTap</p>	<p>2017 Zip introduces Celsius All-in-One Arc and wins Good Design Award</p>	<p>2018 Zip introduces HydroChill high capacity sparkling water systems</p>	<p>2019 Zip launches Micro, our smallest drinking water system and wins Good Design Award in 2020</p>	<p>2020 Zip launches HydroTap Touch-Free Wave, contactless & instant delivery of pure-tasting water</p>	<p>2021 Zip launches HydroTap G5, the fifth generation of HydroTap and HydroTap UltraCare for health and aged care facilities</p>			

ZIP HYDROTAP COMMERCIAL

Classic range

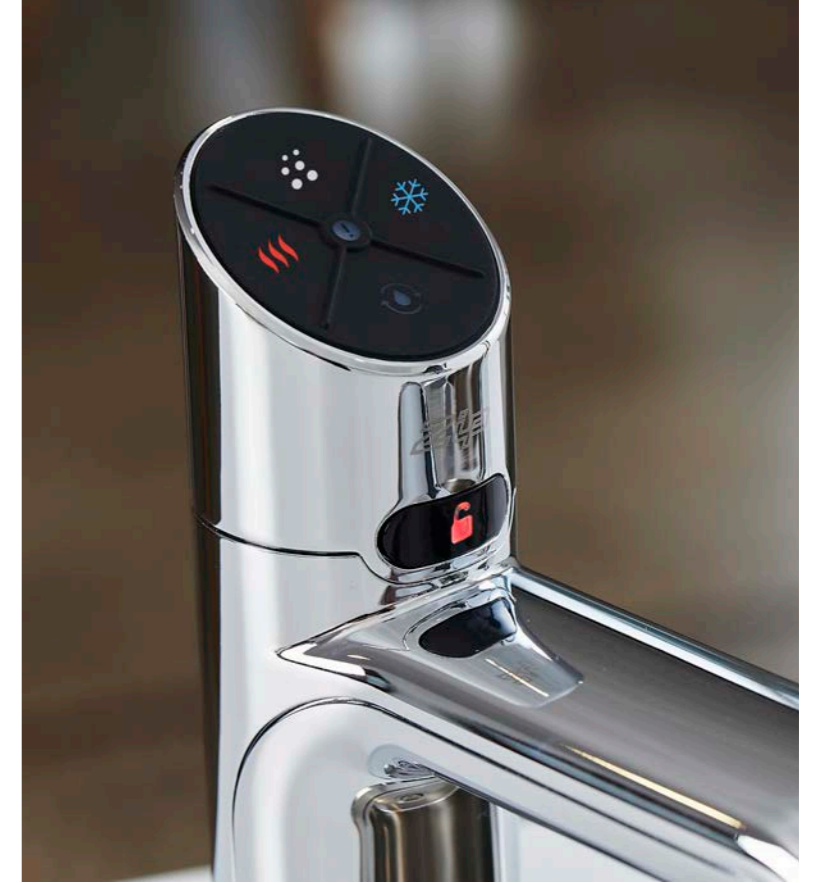

Featured product

Opposite Page - HydroTap Classic All-In-One in Chrome finish

Top Right - HydroTap Classic Plus in Chrome finish

Bottom Right - HydroTap Touch-Free Wave in Chrome finish

Touch-Free Wave

Featured product
HydroTap Touch-Free Wave
in Chrome finish

For workplaces looking to reduce shared touchpoints. Zip HydroTap Touch-Free Wave provides a 100% touch-free solution to instantly dispense pure-tasting drinking water with a simple wave of a hand.



Available water options & finishes:

FILTERED: BOILING CHILLED SPARKLING	FILTERED: BOILING CHILLED	FILTERED: CHILLED SPARKLING	FILTERED: CHILLED	FILTERED: BOILING AMBIENT	FILTERED: BOILING

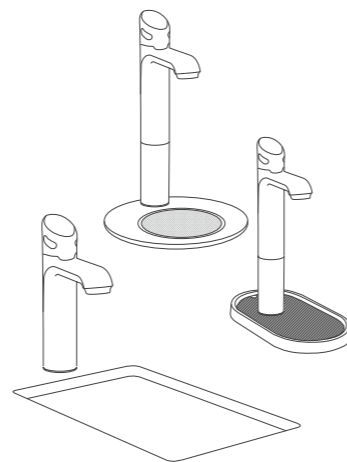

HydroTap Touch-Free Wave can be installed over sink or optional front.



Touch-Free Wave with Mixer

Featured product
HydroTap Touch-Free Wave with Arc Mixer
installed over sink in Matte Black finish

Designed for situations with only a cold water supply. Perfect for workplace kitchens that require a mixer tap and a Zip HydroTap in the same area as well as hot water to the sink.



Classic Mixer

Arc & Cube Mixer

Available water options & finishes:

FILTERED: BOILING CHILLED SPARKLING	UNFILTERED: HOT & COLD	FILTERED: BOILING CHILLED	UNFILTERED: HOT & COLD
5-In-1		4-In-1	

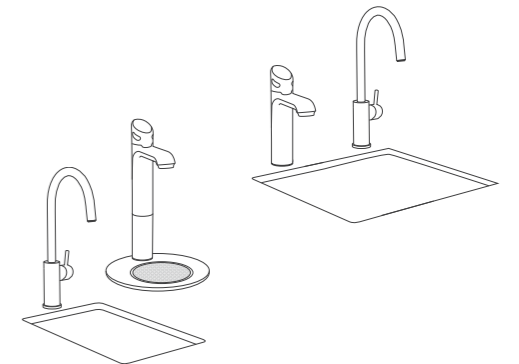

HydroTap Touch-Free Wave can be installed over sink or optional front

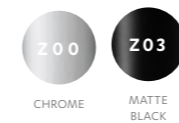

Classic Plus

Featured product
HydroTap Classic Plus installed over sink
in Chrome finish

Offering boiling, chilled and sparkling water in a modern design with intuitive controls.



Available water options & finishes:

FILTERED: BOILING CHILLED SPARKLING	FILTERED: BOILING CHILLED	FILTERED: CHILLED SPARKLING	FILTERED: CHILLED	FILTERED: BOILING AMBIENT	FILTERED: BOILING

POPULAR

- Z00**
CHROME
- Z01**
BRUSHED CHROME
- Z03**
MATTE BLACK

PLATINUM

- Z05**
BRUSHED ROSE GOLD
- Z07**
BRUSHED GOLD
- Z09**
GUNMETAL
- Z11**
BRUSHED NICKEL

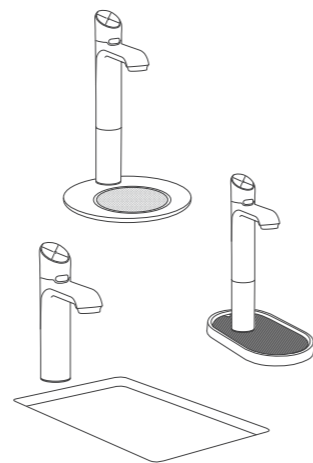

HydroTap Classic Plus can be installed over sink or optional font.

Classic Plus with Mixer

Featured product
HydroTap Classic Plus with Arc Mixer
installed over sink in Matte Black finish

Designed for situations with only a cold water supply. Perfect for workplace kitchens that require a mixer tap and a Zip HydroTap in the same area as well as hot water to the sink.



3.0 litres per minute

In accordance with AS/NZS 6400

Licence No. 0086

Zip Heaters (Aust) Pty Ltd

5.5 litres per minute

In accordance with AS/NZS 6400

Licence No. 0086

Zip Heaters (Aust) Pty Ltd

Classic Mixer Arc & Cube Mixer

Available water options & finishes:

FILTERED: BOILING CHILLED SPARKLING	UNFILTERED: HOT & COLD	FILTERED: BOILING CHILLED	UNFILTERED: HOT & COLD	FILTERED: BOILING	FILTERED: HOT & COLD
5-In-1		4-In-1		3-In-1	

POPULAR

- Z00**
CHROME
- Z01**
BRUSHED CHROME
- Z03**
MATTE BLACK

PLATINUM

- Z05**
BRUSHED ROSE GOLD
- Z07**
BRUSHED GOLD
- Z09**
GUNMETAL
- Z11**
BRUSHED NICKEL

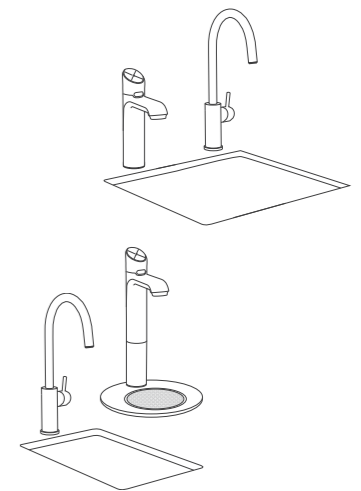

HydroTap Classic Plus can be installed over sink or optional font.

Classic

Featured product
HydroTap Classic installed with optional font
in Chrome finish

Offering the choice of instant filtered boiling, chilled or sparkling water, or all three in any combination, the iconic design of the Classic HydroTap remains a much-loved and popular choice suited to any workplace.



Available water options & finishes:

FILTERED: BOILING CHILLED SPARKLING	FILTERED: BOILING CHILLED	FILTERED: CHILLED SPARKLING	FILTERED: CHILLED	FILTERED: BOILING AMBIENT	FILTERED: BOILING

POPULAR

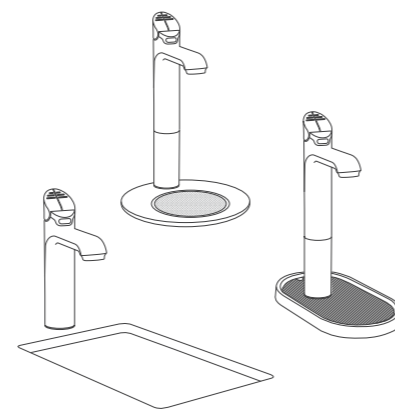

HydroTap Classic can be installed over sink or optional font

Classic with Mixer

Featured product
HydroTap Classic with Arc Mixer installed over sink
in Chrome finish

Designed for situations with only a cold water supply. Perfect for workplace kitchens that require a mixer tap and a Zip HydroTap in the same area as well as hot water to the sink.



3.0 litres per minute

In accordance with AS/NZS 6400
Licence No. 0086
Zip Heaters (Aust) Pty Ltd

Classic Mixer

5.5 litres per minute

In accordance with AS/NZS 6400
Licence No. 0086
Zip Heaters (Aust) Pty Ltd

Arc & Cube Mixer

Available water options & finishes:

FILTERED: BOILING CHILLED SPARKLING	UNFILTERED: HOT & COLD	FILTERED: BOILING CHILLED	UNFILTERED: HOT & COLD	FILTERED: BOILING	FILTERED: HOT & COLD
5-In-1		4-In-1		3-In-1	

POPULAR

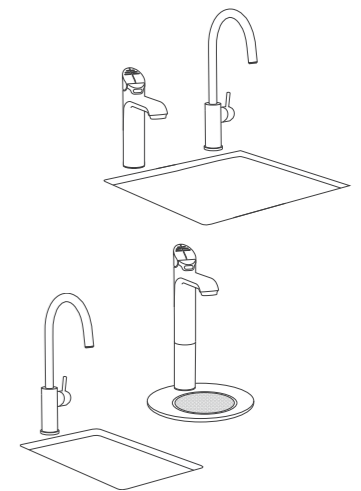
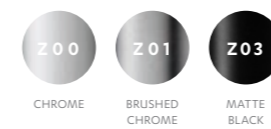

HydroTap Classic can be installed over sink or optional font

Classic All-In-One

Featured product
HydroTap Classic All-In-One installed over sink
in Chrome finish

The Classic HydroTap All-In-One offers filtered boiling, chilled and sparkling water, plus unfiltered hot and cold water from a single tap.



Available water options & finishes:

FILTERED: BOILING CHILLED SPARKLING	UNFILTERED: HOT & COLD	FILTERED: BOILING CHILLED	UNFILTERED: HOT & COLD

POPULAR

- Z00

CHROME
- Z01

BRUSHED CHROME
- Z03

MATTE BLACK

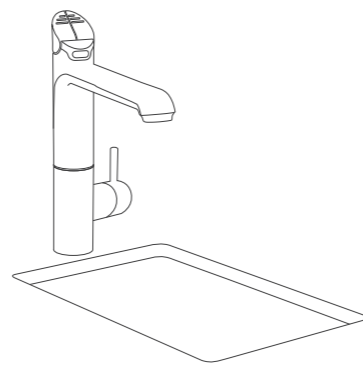

HydroTap Classic All-In-One can be installed over sink only

Classic Industrial

Featured product
HydroTap Classic Industrial installed on
optional font in Chrome finish

For Industrial and Correctional Facilities. Designed with strength and security, the Classic Industrial is proven under the toughest industrial and institutional conditions.



Available water options & finishes:

FILTERED: BOILING CHILLED	FILTERED: BOILING

POPULAR

- Z00

CHROME

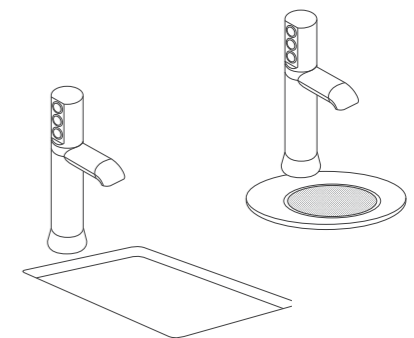

HydroTap Classic Industrial can be installed over sink or optional font

High strength vandal resistant tapered base

Classic for accessibility

Featured product
HydroTap Classic with accessibility levers installed with optional font in Chrome finish

Classic for accessibility is designed for users with limited mobility or impaired vision.



Making life simpler

Provide a truly accessible solution for those with limited mobility or impaired vision by selecting a Zip HydroTap model, supplied with oversized levers with braille covers.



Oversized colour coded braille tap levers

Available water options & finishes:

FILTERED: BOILING CHILLED SPARKLING	FILTERED: BOILING CHILLED	FILTERED: CHILLED SPARKLING	FILTERED: CHILLED	FILTERED: BOILING AMBIENT	FILTERED: BOILING

POPULAR

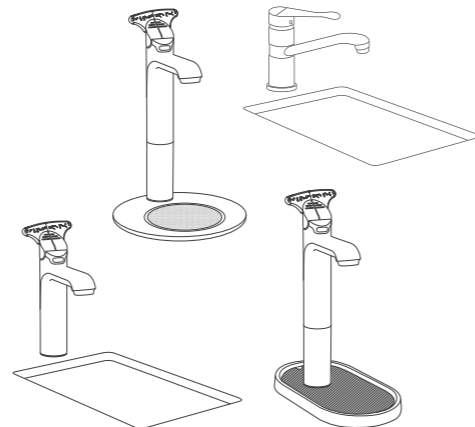
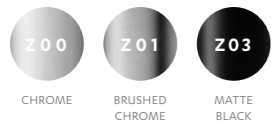

HydroTap Classic with accessibility levers can be installed over sink or optional font

ZIP HYDROTAP COMMERCIAL

Design range



Featured product
HydroTap Arc in
Brushed Nickel finish

Arc

Featured product
HydroTap Arc installed with optional font
in Brushed Gold finish

With an elegant curved shape, the Zip HydroTap Arc will complement any contemporary office or corporate space – available in boiling, chilled or sparkling water, or all three in any combination.



Arc with Mixer

Featured product
HydroTap Arc installed with Arc Mixer
in Chrome finish

Designed for situations with only a cold water supply. Perfect for workplace kitchens that require a mixer tap and a Zip HydroTap in the same area.



Available water options & finishes:

FILTERED: BOILING CHILLED SPARKLING	FILTERED: BOILING CHILLED	FILTERED: CHILLED SPARKLING	FILTERED: CHILLED	FILTERED: BOILING AMBIENT	FILTERED: BOILING

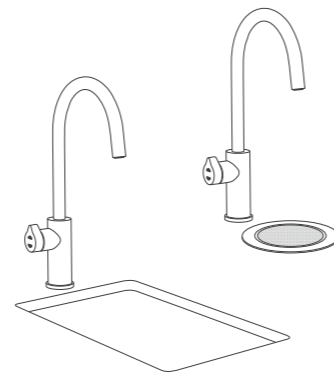

HydroTap Arc can be installed over sink or optional font

POPULAR

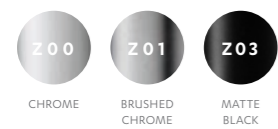

PLATINUM



Available water options & finishes:

FILTERED: BOILING CHILLED SPARKLING	UNFILTERED: HOT & COLD	FILTERED: BOILING CHILLED	UNFILTERED: HOT & COLD	FILTERED: BOILING	FILTERED: HOT & COLD
5-In-1		4-In-1		3-In-1	

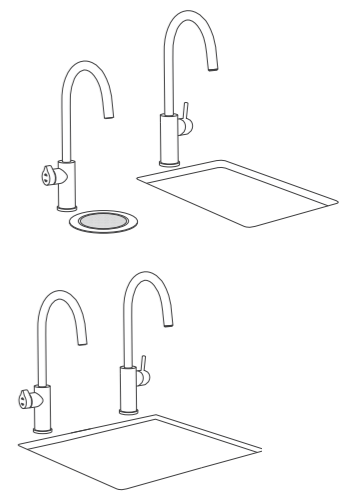

POPULAR

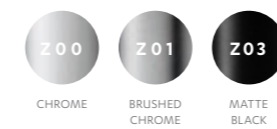

PLATINUM



HydroTap Arc can be installed over sink or optional font

Cube

Featured product
HydroTap Cube installed with optional font
in Gunmetal finish

The stylish Zip HydroTap Cube is both a source of inspiration and a source of wellness – available in boiling, chilled or sparkling water, or all three in any combination.



Available water options & finishes:

FILTERED: BOILING CHILLED SPARKLING	FILTERED: BOILING CHILLED	FILTERED: CHILLED SPARKLING	FILTERED: CHILLED	FILTERED: BOILING AMBIENT	FILTERED: BOILING

POPULAR

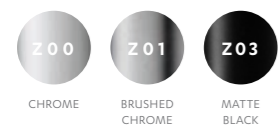

PLATINUM

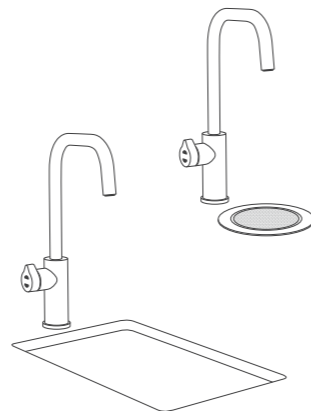

HydroTap Cube can be installed over sink or optional font

Cube with Mixer

Featured product
HydroTap Cube installed with Cube Mixer
in Matte Black finish

Designed for situations with only a cold water supply. Perfect for workplace kitchens that require a mixer tap and a Zip HydroTap in the same area.



Available water options & finishes:

FILTERED: BOILING CHILLED SPARKLING	UNFILTERED: HOT & COLD	FILTERED: BOILING CHILLED	UNFILTERED: HOT & COLD	FILTERED: BOILING	FILTERED: HOT & COLD
5-In-1		4-In-1		3-In-1	

POPULAR

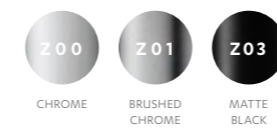

PLATINUM

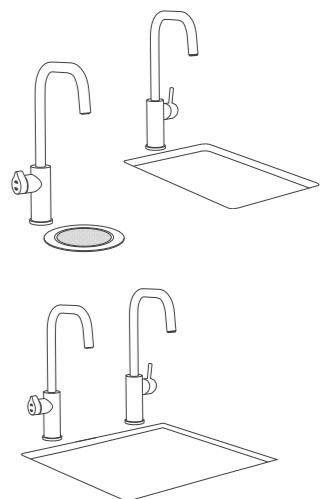

HydroTap Cube can be installed over sink or optional font

Elite Plus

Featured product
HydroTap Elite Plus installed over sink
in Matte Black finish

Form meets function with the sophisticated and innovative Zip HydroTap Elite Plus – available in boiling, chilled or sparkling water, or all three in any combination.



Available water options & finishes:

FILTERED: BOILING CHILLED SPARKLING	FILTERED: BOILING CHILLED	FILTERED: CHILLED SPARKLING	FILTERED: CHILLED	FILTERED: BOILING AMBIENT	FILTERED: BOILING

POPULAR

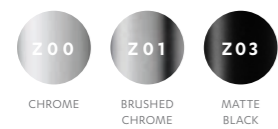

PLATINUM

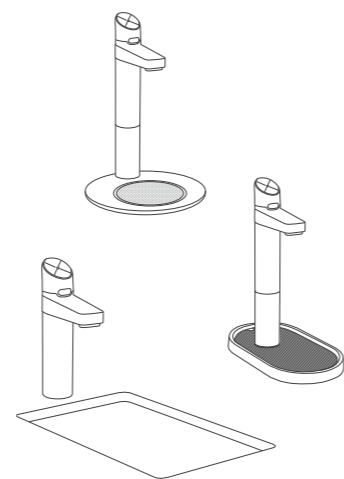

HydroTap Elite Plus can be installed over sink or optional font

Elite Plus with Mixer

Featured product
HydroTap Elite Plus with Arc Mixer installed over
sink in Brushed Chrome finish

Designed for situations with only a cold water supply. Perfect for workplace kitchens that require a mixer tap and a Zip HydroTap in the same area.



3.0 litres per minute

Classic Mixer

5.5 litres per minute

Arc & Cube Mixer

Available water options & finishes:

FILTERED: BOILING CHILLED SPARKLING	UNFILTERED: HOT & COLD	FILTERED: BOILING CHILLED	UNFILTERED: HOT & COLD	FILTERED: BOILING	FILTERED: HOT & COLD
5-In-1		4-In-1		3-In-1	

POPULAR



PLATINUM

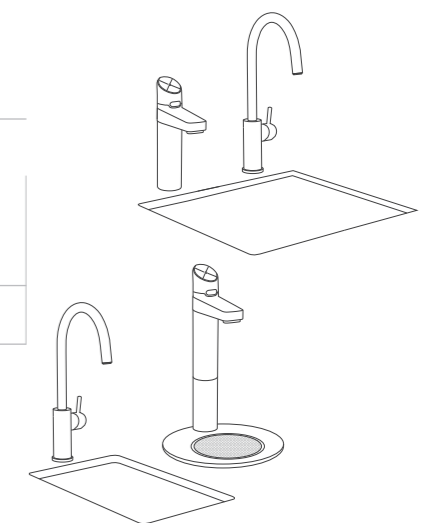

HydroTap Elite Plus can be installed over sink or optional font

ZIP HYDROTAP COMMERCIAL

Celsius range

GOOD DESIGN Award



Featured product
HydroTap Celsius All-In-One
in Brushed Gold finish

Celsius All-In-One

Featured product
HydroTap Celsius All-In-One installed over sink
in Chrome finish

The ultimate in functionality, the All-In-One Celsius Arc is fitted over your sink and offers all five water types – filtered boiling, chilled and sparkling drinking water, plus unfiltered hot and cold water – from a single tap.



*This product needs a hot and cold water supply

Available water options & finishes:

FILTERED: BOILING CHILLED SPARKLING	UNFILTERED: HOT & COLD	FILTERED: BOILING CHILLED	UNFILTERED: HOT & COLD

POPULAR

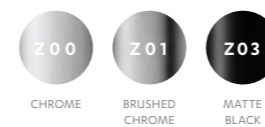

PLATINUM

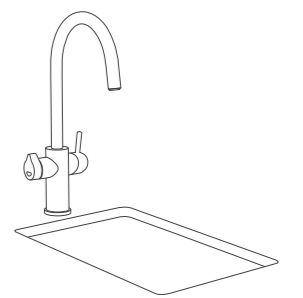

HydroTap Celsius All-In-One can be installed over sink only

Celsius Arc

Featured product
HydroTap Celsius Arc installed over sink
in Brushed Rose Gold finish

The Celsius Arc delivers your choice of filtered boiling, or chilled, or chilled and sparkling water, plus unfiltered hot and cold water – from a single tap.



*This product needs a hot and cold water supply

Available water options & finishes:

FILTERED: CHILLED SPARKLING	UNFILTERED: HOT & COLD	FILTERED: CHILLED	UNFILTERED: HOT & COLD	FILTERED: BOILING	FILTERED: HOT & COLD

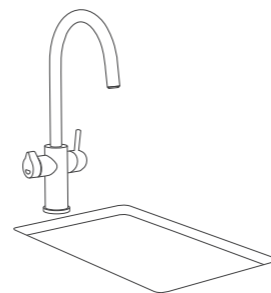

HydroTap Celsius Arc can be installed over sink only

POPULAR

- Z00
CHROME
- Z01
BRUSHED CHROME
- Z03
MATTE BLACK

PLATINUM

- Z05
BRUSHED ROSE GOLD
- Z07
BRUSHED GOLD
- Z09
GUNMETAL
- Z11
BRUSHED NICKEL

Celsius Cube

Featured product
HydroTap Celsius Cube installed over sink
in Brushed Chrome finish

The Celsius Cube delivers your choice of filtered boiling, or chilled, or chilled and sparkling water, plus unfiltered hot and cold water – from a single tap.



*This product needs a hot and cold water supply

Available water options & finishes:

FILTERED: CHILLED SPARKLING	UNFILTERED: HOT & COLD	FILTERED: CHILLED	UNFILTERED: HOT & COLD	FILTERED: BOILING	FILTERED: HOT & COLD

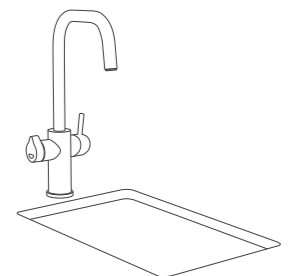

HydroTap Celsius Cube can be installed over sink only

POPULAR

- Z00
CHROME
- Z01
BRUSHED CHROME
- Z03
MATTE BLACK

PLATINUM

- Z05
BRUSHED ROSE GOLD
- Z07
BRUSHED GOLD
- Z09
GUNMETAL
- Z11
BRUSHED NICKEL

Micro

Featured product
HydroTap Micro installed over sink
in Chrome finish

Zip Micro is our smallest system, designed to fit under almost any bench, but still delivers perfectly boiling and chilled water at your fingertips. Zip Micro is perfect for small workplaces with up to 10 people.



Commercial HydroTap

CLASSIC PLUS



ORDER CODE	NO. PEOPLE	MODEL	WATER OPTIONS	CUPS	GLASSES	SIZE*
				PER HOUR	PER HOUR	H x W x D (mm)
H55760Z00AU	20	BCS	[[[[snowflake] [bubbles]]]	100	75	333 x 339 x 460
H55762Z00AU	60			160	175	333 x 395 x 464
H55763Z00AU	100			240*	175	333 x 395 x 464
H55702Z00AU	20	BC	[[[[snowflake]]]	100	75	333 x 280 x 455
H55703Z00AU	40			160	125	333 x 395 x 464
H55704Z00AU	60			160	175	333 x 395 x 464
H55705Z00AU	100	BA	[[[[water drop]]]	240*	175	333 x 395 x 464
H55708Z00AU	60			160	-	333 x 280 x 313
H55709Z00AU	100			240*	-	333 x 280 x 313
H55706Z00AU	60	B	[[[]]	160	-	333 x 280 x 313
H55707Z00AU	100			240*	-	333 x 280 x 313
H55765Z00AU	100	CS	[snowflake] [bubbles]	-	150	333 x 280 x 480
H55710Z00AU	40	C	[snowflake]	-	125	333 x 280 x 476
H55711Z00AU	100			-	150	333 x 280 x 476

CLASSIC PLUS WITH CLASSIC MIXER

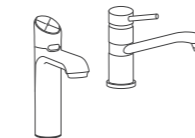

H55675Z00AU	60	BCSHA	[[[[snowflake] [bubbles] [mixer]]]	160	175	333 x 395 x 464
H55676Z00AU	100			240*	175	333 x 395 x 464
H55621Z00AU	20	BCHA	[[[[snowflake] [mixer]]]	100	75	333 x 280 x 455
H55622Z00AU	40			160	125	333 x 395 x 464
H55623Z00AU	60			160	175	333 x 395 x 464
H55624Z00AU	100			240*	175	333 x 395 x 464

Available water options & finishes:

FILTERED: BOILING CHILLED	FILTERED: BOILING
[[[[snowflake]]]	[[[]]

POPULAR

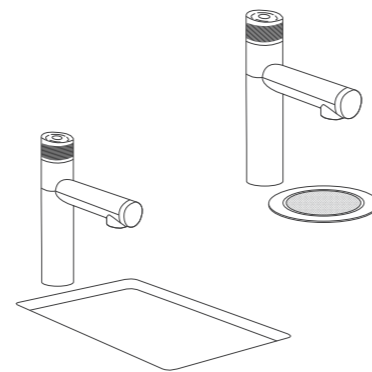
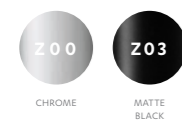

HydroTap Micro can be installed over sink or optional front

AVAILABLE IN:

POPULAR

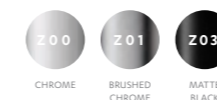

PLATINUM

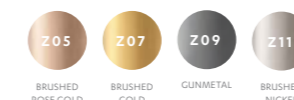

Order code listed above is for Chrome finish. To select a different finish, replace Z00 with the relevant colour code. For example, HydroTap G5 BCS20 Classic Plus in a Matte Black finish use code H51760Z03AU.

KEY TO ICONS

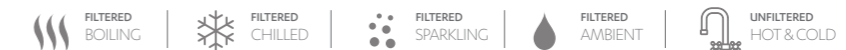

*240 boiling cup per hour models include additional Booster and require 2 x 10 amp power GPOs. Refer to zipwater.com for full specification details.

Size relates to command centre - revert to installation diagram for clearance and ventilation.

Class size is 200ml and cup size 167ml.

'Ambient' describes the temperature of the water where there is no additional heating or chilling to the incoming cold water supply.

Commercial HydroTap

CLASSIC PLUS WITH ARC MIXER

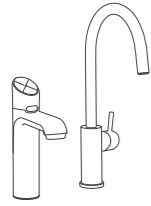

ORDER CODE	NO. PEOPLE	MODEL	WATER OPTIONS	CUPS PER HOUR	GLASSES PER HOUR	SIZE* H x W x D (mm)
H55875Z00AU	60	BCSHA		160	175	333 x 395 x 464
H55876Z00AU	100			240*	175	333 x 395 x 464
H55821Z00AU	20	BCHA		100	75	333 x 280 x 455
H55822Z00AU	40			160	125	333 x 395 x 464
H55823Z00AU	60			160	175	333 x 395 x 464
H55824Z00AU	100			240*	175	333 x 395 x 464
H55856Z00AU	60	BHA		160	-	333 x 280 x 313
H55857Z00AU	100			240*	-	333 x 280 x 313

CLASSIC PLUS WITH CUBE MIXER

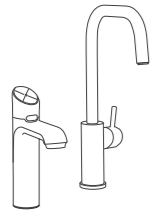

ORDER CODE	NO. PEOPLE	MODEL	WATER OPTIONS	CUPS PER HOUR	GLASSES PER HOUR	SIZE* H x W x D (mm)
H55975Z00AU	60	BCSHA		160	175	333 x 395 x 464
H55976Z00AU	100			240*	175	333 x 395 x 464
H55921Z00AU	20	BCHA		100	75	333 x 280 x 455
H55922Z00AU	40			160	125	333 x 395 x 464
H55923Z00AU	60			160	175	333 x 395 x 464
H55924Z00AU	100			240*	175	333 x 395 x 464
H55956Z00AU	60	BHA		160	-	333 x 280 x 313
H55957Z00AU	100			240*	-	333 x 280 x 313

AVAILABLE IN:



Order code listed above is for Chrome finish. To select a different finish, replace Z00 with the relevant colour code. For example, HydroTap GS BCSHA60 Classic Plus in a Matte Black finish use code H55875Z03AU.



*240 boiling cup per hour models include additional Booster and require 2 x 10 amp power GPOs. Refer to zipwater.com for full specification details.

Size relates to command centre - revert to installation diagram for clearance and ventilation.

Glass size is 200ml and cup size 167ml.

'Ambient' describes the temperature of the water where there is no additional heating or chilling to the incoming cold water supply.

TOUCH-FREE WAVE



ORDER CODE	NO. PEOPLE	MODEL	WATER OPTIONS	CUPS PER HOUR	GLASSES PER HOUR	SIZE* H x W x D (mm)
H5W760Z00AU	20	BCS		100	75	333 x 339 x 460
H5W762Z00AU	60			160	175	333 x 395 x 464
H5W763Z00AU	100			240*	175	333 x 395 x 464
H5W702Z00AU	20	BC		100	75	333 x 280 x 455
H5W703Z00AU	40			160	125	333 x 395 x 464
H5W704Z00AU	60			160	175	333 x 395 x 464
H5W705Z00AU	100			240*	175	333 x 395 x 464
H5W708Z00AU	60	BA		160	-	333 x 280 x 313
H5W706Z00AU	60	B		160	-	333 x 280 x 313
H5W707Z00AU	100			240*	-	333 x 280 x 313
H5W765Z00AU	100	CS		-	150	333 x 280 x 480
H5W710Z00AU	40	C		-	125	333 x 280 x 476
H5W711Z00AU	100			-	150	333 x 280 x 476

TOUCH-FREE WAVE WITH CLASSIC MIXER

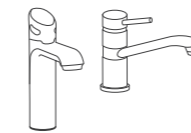

H5W675Z00AU	60	BCSHA		160	175	333 x 395 x 464
H5W676Z00AU	100			240*	175	333 x 395 x 464
H5W621Z00AU	20	BCHA		100	75	333 x 280 x 455
H5W622Z00AU	40			160	125	333 x 395 x 464
H5W623Z00AU	60			160	175	333 x 395 x 464
H5W624Z00AU	100			240*	175	333 x 395 x 464

AVAILABLE IN:

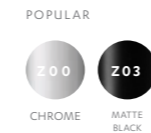

Order code listed above is for Chrome finish. To select a different finish, replace Z00 with the relevant colour code. For example, HydroTap GS BCS20 Touch-Free Wave in a Matte Black finish use code H5W760Z03AU.



*240 boiling cup per hour models include additional Booster and require 2 x 10 amp power GPOs. Refer to zipwater.com for full specification details.

Size relates to command centre - revert to installation diagram for clearance and ventilation.

Glass size is 200ml and cup size 167ml.

'Ambient' describes the temperature of the water where there is no additional heating or chilling to the incoming cold water supply.

Commercial HydroTap

TOUCH-FREE WAVE WITH ACCESSIBLE MIXER

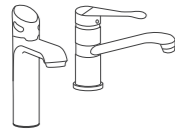

ORDER CODE	NO. PEOPLE	MODEL	WATER OPTIONS	CUPS PER HOUR	GLASSES PER HOUR	SIZE* H x W x D (mm)
H5WD21Z00AU	20	BCHA		100	75	333 x 280 x 455
H5WD22Z00AU	40			160	125	333 x 395 x 464
H5WD23Z00AU	60			160	175	333 x 395 x 464
H5WD24Z00AU	100			240*	175	333 x 395 x 464

TOUCH-FREE WAVE WITH ARC MIXER

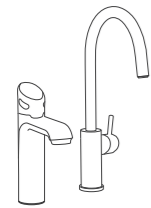

ORDER CODE	NO. PEOPLE	MODEL	WATER OPTIONS	CUPS PER HOUR	GLASSES PER HOUR	SIZE* H x W x D (mm)
H5W875Z00AU	60	BCSHA		160	175	333 x 395 x 464
H5W876Z00AU	100			240*	175	333 x 395 x 464
H5W821Z00AU	20	BCHA		100	75	333 x 280 x 455
H5W822Z00AU	40			160	125	333 x 395 x 464
H5W823Z00AU	60			160	175	333 x 395 x 464
H5W824Z00AU	100			240*	175	333 x 395 x 464

TOUCH-FREE WAVE WITH CUBE MIXER

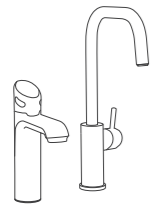

ORDER CODE	NO. PEOPLE	MODEL	WATER OPTIONS	CUPS PER HOUR	GLASSES PER HOUR	SIZE* H x W x D (mm)
H5W975Z00AU	60	BCSHA		160	175	333 x 395 x 464
H5W976Z00AU	100			240*	175	333 x 395 x 464
H5W921Z00AU	20	BCHA		100	75	333 x 280 x 455
H5W922Z00AU	40			160	125	333 x 395 x 464
H5W923Z00AU	60			160	175	333 x 395 x 464
H5W924Z00AU	100			240*	175	333 x 395 x 464

AVAILABLE IN:

POPULAR



Order code listed above is for Chrome finish. To select a different finish, replace Z00 with the relevant colour code. For example, HydroTap GS BCHA20 Touch-Free Wave in a Matte Black finish use code H5WD21Z03AU.

KEY TO ICONS

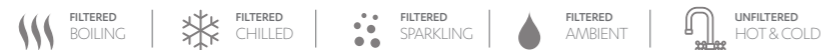

*240 boiling cup per hour models include additional Booster and require 2 x 10 amp power GPOs. Refer to zipwater.com for full specification details.

Size relates to command centre - revert to installation diagram for clearance and ventilation.

Glass size is 200ml and cup size 167ml.

'Ambient' describes the temperature of the water where there is no additional heating or chilling to the incoming cold water supply.

CLASSIC



ORDER CODE	NO. PEOPLE	MODEL	WATER OPTIONS	CUPS PER HOUR	GLASSES PER HOUR	SIZE* H x W x D (mm)
H51760Z00AU	20	BCS		100	75	333 x 339 x 460
H51762Z00AU	60			160	175	333 x 395 x 464
H51763Z00AU	100			240*	175	333 x 395 x 464
H51702Z00AU	20	BC		100	75	333 x 280 x 455
H51703Z00AU	40			160	125	333 x 395 x 464
H51704Z00AU	60			160	175	333 x 395 x 464
H51705Z00AU	100			240*	175	333 x 395 x 464
H51708Z00AU	60	BA		160	-	333 x 280 x 313
H51709Z00AU	100			240*	-	333 x 280 x 313
H51706Z00AU	60	B		160	-	333 x 280 x 313
H51707Z00AU	100			240*	-	333 x 280 x 313
H51765Z00AU	100	CS		-	150	333 x 280 x 480
H51710Z00AU	40	C		-	125	333 x 280 x 476
H51711Z00AU	100			-	150	333 x 280 x 476

CLASSIC WITH CLASSIC MIXER

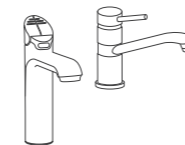

H51675Z00AU	60	BCSHA		160	175	333 x 395 x 464
H51676Z00AU	100			240*	175	333 x 395 x 464
H51621Z00AU	20	BCHA		100	75	333 x 280 x 455
H51622Z00AU	40			160	125	333 x 395 x 464
H51623Z00AU	60			160	175	333 x 395 x 464
H51624Z00AU	100			240*	175	333 x 395 x 464
H51656Z00AU	60	BHA		160	-	333 x 280 x 313
H51657Z00AU	100			240*	-	333 x 280 x 313

AVAILABLE IN:

POPULAR

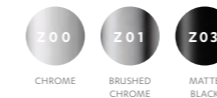

Order code listed above is for Chrome finish. To select a different finish, replace Z00 with the relevant colour code. For example, HydroTap GS BCS20 Classic in a Matte Black finish use code H51760Z03AU.

KEY TO ICONS



*240 boiling cup per hour models include additional Booster and require 2 x 10 amp power GPOs. Refer to zipwater.com for full specification details.

Size relates to command centre - revert to installation diagram for clearance and ventilation.

Glass size is 200ml and cup size 167ml.

'Ambient' describes the temperature of the water where there is no additional heating or chilling to the incoming cold water supply.

Commercial HydroTap

CLASSIC WITH ARC MIXER

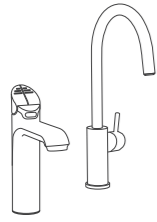

ORDER CODE	NO. PEOPLE	MODEL	WATER OPTIONS	CUPS PER HOUR	GLASSES PER HOUR	SIZE* H x W x D (mm)
H51875Z00AU	60	BCSHA		160	175	333 x 395 x 464
H51876Z00AU	100			240*	175	333 x 395 x 464
H51821Z00AU	20	BCHA		100	75	333 x 280 x 455
H51822Z00AU	40			160	125	333 x 395 x 464
H51823Z00AU	60			160	175	333 x 395 x 464
H51824Z00AU	100			240*	175	333 x 395 x 464
H51856Z00AU	60	BHA		160	-	333 x 280 x 313
H51857Z00AU	100			240*	-	333 x 280 x 313

CLASSIC WITH CUBE MIXER

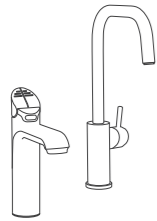

H51975Z00AU	60	BCSHA		160	175	333 x 395 x 464
H51976Z00AU	100			240*	175	333 x 395 x 464
H51921Z00AU	20	BCHA		100	75	333 x 280 x 455
H51922Z00AU	40			160	125	333 x 395 x 464
H51923Z00AU	60			160	175	333 x 395 x 464
H51924Z00AU	100			240*	175	333 x 395 x 464
H51956Z00AU	60	BHA		160	-	333 x 280 x 313
H51957Z00AU	100			240*	-	333 x 280 x 313

CLASSIC ALL-IN-ONE

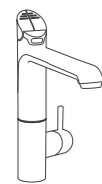

H5A775Z00AU	60	BCSHA		160	175	333 x 395 x 464
H5A776Z00AU	100			240*	175	333 x 395 x 464
H5A722Z00AU	40	BCHA		160	125	333 x 395 x 464
H5A723Z00AU	60			160	175	333 x 395 x 464
H5A724Z00AU	100			240*	175	333 x 395 x 464

AVAILABLE IN:

POPULAR

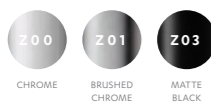

Order code listed above is for Chrome finish. To select a different finish, replace Z00 with the relevant colour code. For example, HydroTap GS BCSHA60 Classic with Arc Mixer in a Matte Black finish use code H51875Z03AU.

KEY TO ICONS

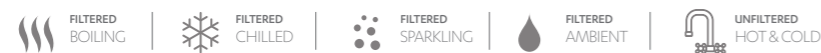

*240 boiling cup per hour models include additional Booster and require 2 x 10 amp power GPOs. Refer to zipwater.com for full specification details.

Size relates to command centre - revert to installation diagram for clearance and ventilation.

Glass size is 200ml and cup size 167ml.

'Ambient' describes the temperature of the water where there is no additional heating or chilling to the incoming cold water supply.

CLASSIC INDUSTRIAL SIDE TOUCH**

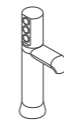

ORDER CODE	NO. PEOPLE	MODEL	WATER OPTIONS	CUPS PER HOUR	GLASSES PER HOUR	SIZE* H x W x D (mm)
H5J703Z00AU	40	BC		160	125	333 x 395 x 464
H5J704Z00AU	60			160	175	333 x 395 x 464
H5J705Z00AU	100			240*	175	333 x 395 x 464

CLASSIC INDUSTRIAL TOP TOUCH**

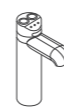

H5I703Z00AU	40	BC		160	125	333 x 395 x 464
H5I704Z00AU	60			160	175	333 x 395 x 464
H5I705Z00AU	100			240*	175	333 x 395 x 464

MICRO

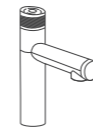

M1005AU	10	BC		90	60	340 x 180 x 502
M1001AU	10	B		90	-	340 x 180 x 270

ULTRACARE**



H517U1Z00AUC



H5D7U1Z00AUC



H5W7U1Z00AUC

H5W7U1Z00AUC	40	BCU		160	125	333 x 395 x 464
H5D7U1Z00AUC	40	BCU		160	125	333 x 395 x 464
H517U1Z00AUC	40	BCU		160	125	333 x 395 x 464

AVAILABLE IN:

POPULAR

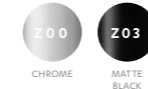

Order code listed above is for Chrome finish.

KEY TO ICONS



*240 boiling cup per hour models include additional Booster and require 2 x 10 amp power GPOs. Refer to zipwater.com for full specification details.

Size relates to command centre - revert to installation diagram for clearance and ventilation.

Glass size is 200ml and cup size 167ml.

**Industrial & UltraCare products only available in Chrome finish.

'Ambient' describes the temperature of the water where there is no additional heating or chilling to the incoming cold water supply.

Commercial HydroTap

ARC

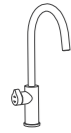

ORDER CODE	NO. PEOPLE	MODEL	WATER OPTIONS	CLIPS PER HOUR	GLASSES PER HOUR	SIZE* H x W x D (mm)
H52760Z00AU	20	BCS		100	75	333 x 339 x 460
H52762Z00AU	60			160	175	333 x 395 x 464
H52763Z00AU	100			240*	175	333 x 395 x 464
H52702Z00AU	20	BC		100	75	333 x 280 x 455
H52703Z00AU	40			160	125	333 x 395 x 464
H52704Z00AU	60			160	175	333 x 395 x 464
H52705Z00AU	100			240*	175	333 x 395 x 464
H52708Z00AU	60	BA		160	-	333 x 280 x 313
H52709Z00AU	100			240*	-	333 x 280 x 313
H52706Z00AU	60	B		160	-	333 x 280 x 313
H52707Z00AU	100			240*	-	333 x 280 x 313
H52765Z00AU	100	CS		-	150	333 x 280 x 480
H52710Z00AU	40	C		-	125	333 x 280 x 476
H52711Z00AU	100			-	150	333 x 280 x 476

CUBE

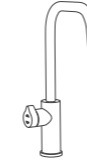

ORDER CODE	NO. PEOPLE	MODEL	WATER OPTIONS	CLIPS PER HOUR	GLASSES PER HOUR	SIZE* H x W x D (mm)
H53760Z00AU	20	BCS		100	75	333 x 339 x 460
H53762Z00AU	60			160	175	333 x 395 x 464
H53763Z00AU	100			240*	175	333 x 395 x 464
H53702Z00AU	20	BC		100	75	333 x 280 x 455
H53703Z00AU	40			160	125	333 x 395 x 464
H53704Z00AU	60			160	175	333 x 395 x 464
H53705Z00AU	100			240*	175	333 x 395 x 464
H53708Z00AU	60	BA		160	-	333 x 280 x 313
H53709Z00AU	100			240*	-	333 x 280 x 313
H53706Z00AU	60	B		160	-	333 x 280 x 313
H53707Z00AU	100			240*	-	333 x 280 x 313
H53765Z00AU	100	CS		-	150	333 x 280 x 480
H53710Z00AU	40	C		-	125	333 x 280 x 476
H53711Z00AU	100			-	150	333 x 280 x 476

ARC WITH ARC MIXER



H52875Z00AU	60	BCSHA		160	175	333 x 395 x 464
H52876Z00AU	100			240*	175	333 x 395 x 464
H52822Z00AU	40	BCHA		160	125	333 x 395 x 464
H52823Z00AU	60			160	175	333 x 395 x 464
H52824Z00AU	100			240*	175	333 x 395 x 464
H52856Z00AU	60	BHA		160	-	333 x 280 x 313
H52857Z00AU	100			240*	-	333 x 280 x 313

CUBE WITH CUBE MIXER

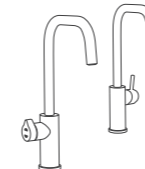

H53975Z00AU	60	BCSHA		160	175	333 x 395 x 464
H53976Z00AU	100			240*	175	333 x 395 x 464
H53922Z00AU	40	BCHA		160	125	333 x 395 x 464
H53923Z00AU	60			160	175	333 x 395 x 464
H53924Z00AU	100			240*	175	333 x 395 x 464
H53956Z00AU	60	BHA		160	-	333 x 280 x 313
H53957Z00AU	100			240*	-	333 x 280 x 313

AVAILABLE IN:



Order code listed above is for Chrome finish. To select a different finish, replace Z00 with the relevant colour code. For example, HydroTap GS BCS20 Arc in a Matte Black finish use code H52760Z03AU.



*240 boiling cup per hour models include additional Booster and require 2 x 10 amp power GPOs. Refer to zipwater.com for full specification details.
 Size relates to command centre - revert to installation diagram for clearance and ventilation.
 Glass size is 200ml and cup size 167ml.
 'Ambient' describes the temperature of the water where there is no additional heating or chilling to the incoming cold water supply.

AVAILABLE IN:



Order code listed above is for Chrome finish. To select a different finish, replace Z00 with the relevant colour code. For example, HydroTap GS BCS20 Cube in a Matte Black finish use code H53760Z03AU.



*240 boiling cup per hour models include additional Booster and require 2 x 10 amp power GPOs. Refer to zipwater.com for full specification details.
 Size relates to command centre - revert to installation diagram for clearance and ventilation.
 Glass size is 200ml and cup size 167ml.
 'Ambient' describes the temperature of the water where there is no additional heating or chilling to the incoming cold water supply.

Commercial HydroTap

ELITE PLUS

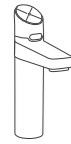

ORDER CODE	NO. PEOPLE	MODEL	WATER OPTIONS	CUPS PER HOUR	GLASSES PER HOUR	SIZE* H x W x D (mm)
H5E760Z00AU	20	BCS		100	75	333 x 339 x 460
H5E762Z00AU	60			160	175	333 x 395 x 464
H5E763Z00AU	100			240*	175	333 x 395 x 464
H5E702Z00AU	20	BC		100	75	333 x 280 x 455
H5E703Z00AU	40			160	125	333 x 395 x 464
H5E704Z00AU	60			160	175	333 x 395 x 464
H5E705Z00AU	100			240*	175	333 x 395 x 464
H5E708Z00AU	60	BA		160	-	333 x 280 x 313
H5E709Z00AU	100			240*	-	333 x 280 x 313
H5E706Z00AU	60	B		160	-	333 x 280 x 313
H5E707Z00AU	100			240*	-	333 x 280 x 313
H5E765Z00AU	100	CS		-	150	333 x 280 x 480
H5E710Z00AU	40	C		-	125	333 x 280 x 476
H5E711Z00AU	100			-	150	333 x 280 x 476

ELITE PLUS WITH CLASSIC MIXER

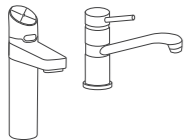

H5E675Z00AU	60	BCSHA		160	175	333 x 395 x 464
H5E676Z00AU	100			240*	175	333 x 395 x 464
H5E622Z00AU	40	BCHA		160	125	333 x 395 x 464
H5E623Z00AU	60			160	175	333 x 395 x 464
H5E624Z00AU	100			240*	175	333 x 395 x 464
H5E656Z00AU	60	BHA		160	-	333 x 280 x 313
H5E657Z00AU	100			240*	-	333 x 280 x 313

AVAILABLE IN:



Order code listed above is for Chrome finish. To select a different finish, replace Z00 with the relevant colour code. For example, HydroTap G5 BCS20 Elite Plus in a Matte Black finish use code H5E760Z03AU.

KEY TO ICONS

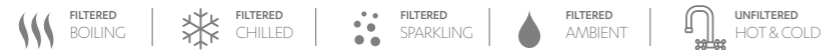

*240 boiling cup per hour models include additional Booster and require 2 x 10 amp power GPOs. Refer to zipwater.com for full specification details.

Size relates to command centre - revert to installation diagram for clearance and ventilation.

Glass size is 200ml and cup size 167ml.

'Ambient' describes the temperature of the water where there is no additional heating or chilling to the incoming cold water supply.

ELITE PLUS WITH ARC MIXER

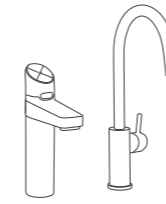

ORDER CODE	NO. PEOPLE	MODEL	WATER OPTIONS	CUPS PER HOUR	GLASSES PER HOUR	SIZE* H x W x D (mm)
H5E875Z00AU	60	BCSHA		160	175	333 x 395 x 464
H5E876Z00AU	100			240*	175	333 x 395 x 464
H5E822Z00AU	40	BCHA		160	125	333 x 395 x 464
H5E823Z00AU	60			160	175	333 x 395 x 464
H5E824Z00AU	100			240*	175	333 x 395 x 464
H5E856Z00AU	60	BHA		160	-	333 x 280 x 313
H5E857Z00AU	100			240*	-	333 x 280 x 313

ELITE PLUS WITH CUBE MIXER

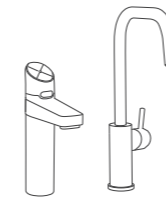

ORDER CODE	NO. PEOPLE	MODEL	WATER OPTIONS	CUPS PER HOUR	GLASSES PER HOUR	SIZE* H x W x D (mm)
H5E975Z00AU	60	BCSHA		160	175	333 x 395 x 464
H5E976Z00AU	100			240*	175	333 x 395 x 464
H5E922Z00AU	40	BCHA		160	125	333 x 395 x 464
H5E923Z00AU	60			160	175	333 x 395 x 464
H5E924Z00AU	100			240*	175	333 x 395 x 464
H5E956Z00AU	60	BHA		160	-	333 x 280 x 313
H5E957Z00AU	100			240*	-	333 x 280 x 313

AVAILABLE IN:



Order code listed above is for Chrome finish. To select a different finish, replace Z00 with the relevant colour code. For example, HydroTap G5 BCSHA60 5-In-1 Elite Plus tap with Arc Mixer in a Matte Black finish use code H5E875Z03AU.

KEY TO ICONS



*240 boiling cup per hour models include additional Booster and require 2 x 10 amp power GPOs. Refer to zipwater.com for full specification details.

Size relates to command centre - revert to installation diagram for clearance and ventilation.

Glass size is 200ml and cup size 167ml.

'Ambient' describes the temperature of the water where there is no additional heating or chilling to the incoming cold water supply.

Commercial HydroTap

CELSIUS ALL-IN-ONE**

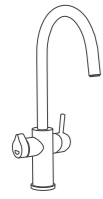

ORDER CODE	NO. PEOPLE	MODEL	WATER OPTIONS	CUPS PER HOUR	GLASSES PER HOUR	SIZE* H x W x D (mm)
H57760Z00AU	20	BCSHA		100	75	333 x 339 x 460
H57762Z00AU	60			160	175	333 x 395 x 464
H57763Z00AU	100			240*	175	333 x 395 x 464
H57702Z00AU	20	BCHA		100	75	333 x 280 x 455
H57703Z00AU	40			160	125	333 x 395 x 464
H57704Z00AU	60			160	175	333 x 395 x 464
H57705Z00AU	100			240	175	333 x 395 x 464

CELSIUS ARC**

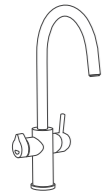

ORDER CODE	NO. PEOPLE	MODEL	WATER OPTIONS	CUPS PER HOUR	GLASSES PER HOUR	SIZE* H x W x D (mm)
H58706Z00AU	60	B		160	-	333 x 280 x 313
H58707Z00AU	100			240*	-	333 x 280 x 313
H58765Z00AU	100	CS		-	150	333 x 280 x 480
H58711Z00AU	100	C		-	150	333 x 280 x 476

CELSIUS CUBE**

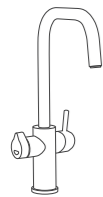

MODEL CODE	NO. PEOPLE	MODEL	WATER OPTIONS	CUPS PER HOUR	GLASSES PER HOUR	SIZE* H x W x D (mm)
H59706Z00AU	60	B		160	-	333 x 280 x 313
H59707Z00AU	100			240*	-	333 x 280 x 313
H59765Z00AU	100	CS		-	150	333 x 280 x 480
H59711Z00AU	100	C		-	150	333 x 280 x 476

**Celsius products require a hot and cold water supply

AVAILABLE IN:

POPULAR

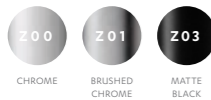

PLATINUM



Order code listed above is for Chrome finish. To select a different finish, replace Z00 with the relevant colour code. For example, HydroTap G5 BCSHA20 Elite in a Matte Black finish use code H57760Z03AU.

KEY TO ICONS

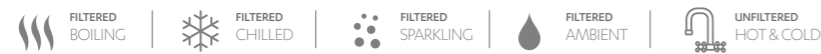

*240 boiling cup per hour models include additional Booster and require 2 x 10 amp power GPOs. Refer to zipwater.com for full specification details.

Size relates to command centre - revert to installation diagram for clearance and ventilation.

Glass size is 200ml and cup size 167ml.

'Ambient' describes the temperature of the water where there is no additional heating or chilling to the incoming cold water supply.

Technical information

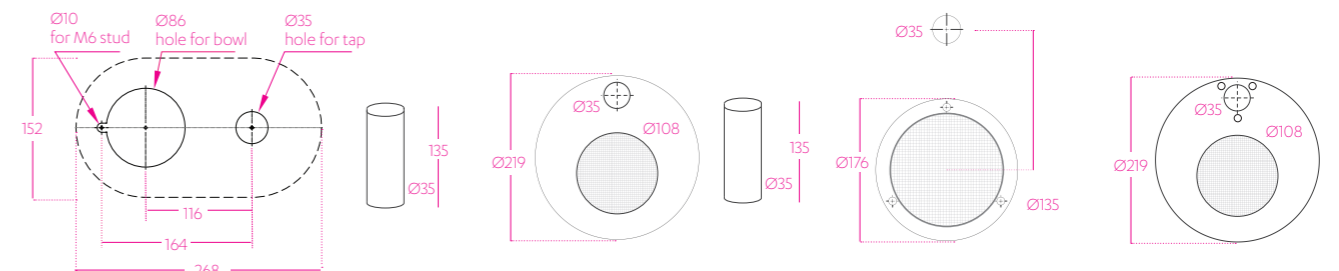
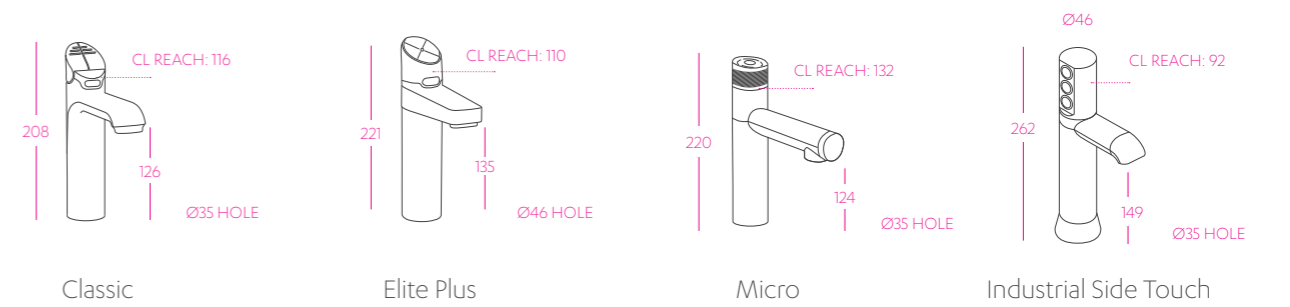
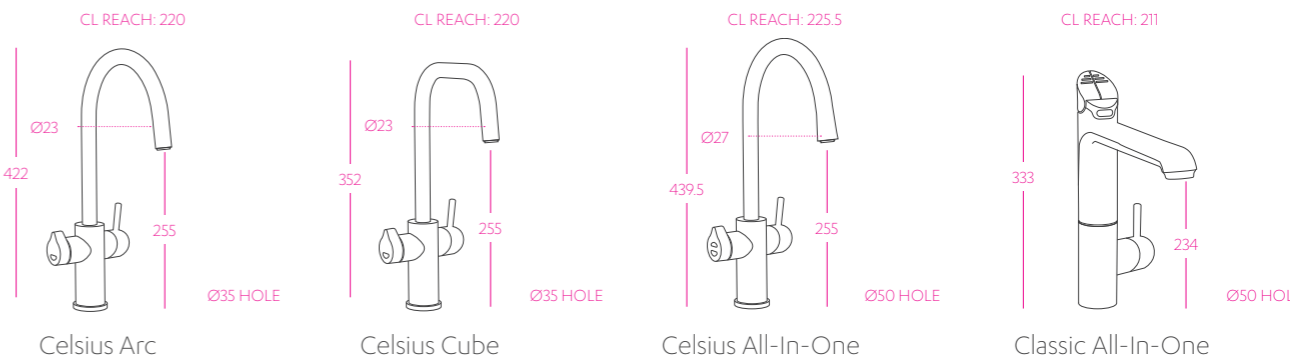
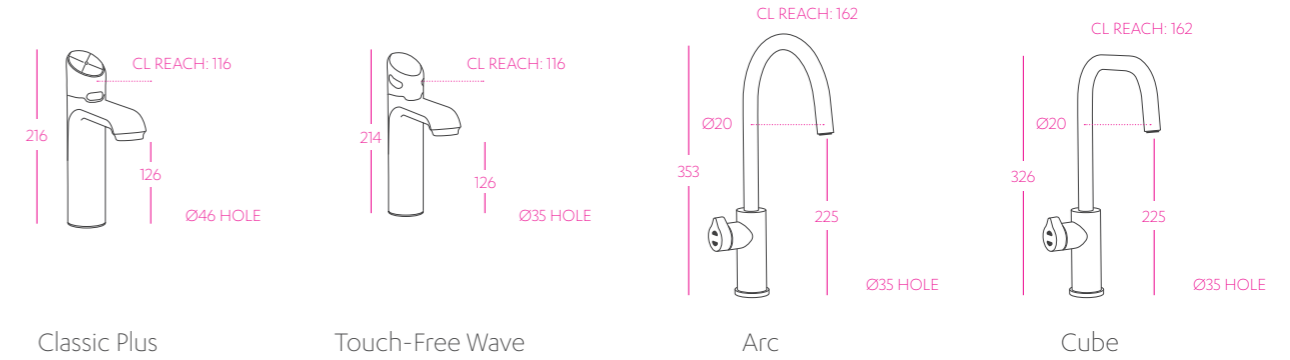

95258Z00

Zip font raised Chrome

Suits any current model Zip HydroTap Classic, Classic Plus, Touch-Free Wave, Miniboil Classic and Elite Plus

90915Z00

Zip font kit Chrome

Suits any current model Zip HydroTap Classic, Classic Plus, Touch-Free Wave, Miniboil Classic and Elite Plus

93441Z00

Zip stand alone font Chrome for HydroTap Arc and Cube

90869Z00

Font for Industrial in Chrome finish

Technical information

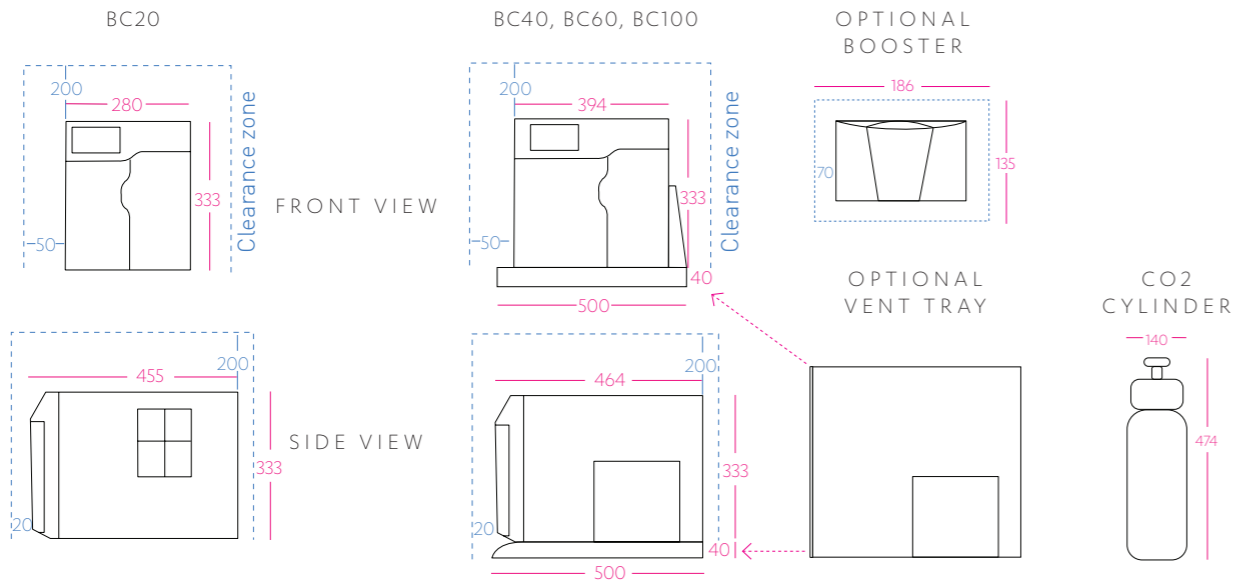

For full installation details please refer to the installation instructions which can be found at zipwater.com. Be sure to allow additional space required if installing a sparkling model with CO2 cylinder.



Image shows BC40 command centre installed with vent tray

Accessories

90915Z00
Zip font kit Chrome

Suits current model Zip HydroTap Classic, Classic Plus, Touch-Free Wave, Miniboil Classic and Elite Plus

Available in popular finish options only

POPULAR

Z00
CHROME

Z01
BRUSHED CHROME

Z03
MATTE BLACK

93441Z00
Zip stand alone font Chrome

Suits current model HydroTap Arc or Cube. Does not include extension

Available in 7 colour finish options

POPULAR

Z00
CHROME

Z01
BRUSHED CHROME

Z03
MATTE BLACK

95258Z00
Zip font raised Chrome

Suits current model Zip HydroTap Classic, Classic Plus, Touch-Free Wave, Miniboil Classic and Elite Plus

Available in 7 colour finish options

PLATINUM

Z05
BRUSHED ROSE GOLD

Z07
BRUSHED GOLD

Z09
GUNMETAL

Z11
BRUSHED NICKEL

91564
Zip BCS accessibility lever

Available in various configurations to suit your needs. Compatible with HydroTap Classic only

91560
Zip BC accessibility lever



1800 947 827

zipwater.com